

HYUNDAI
POWER PRODUCTS

VACUUM/BLOWER

HAS30TCL

ORIGINAL INSTRUCTIONS

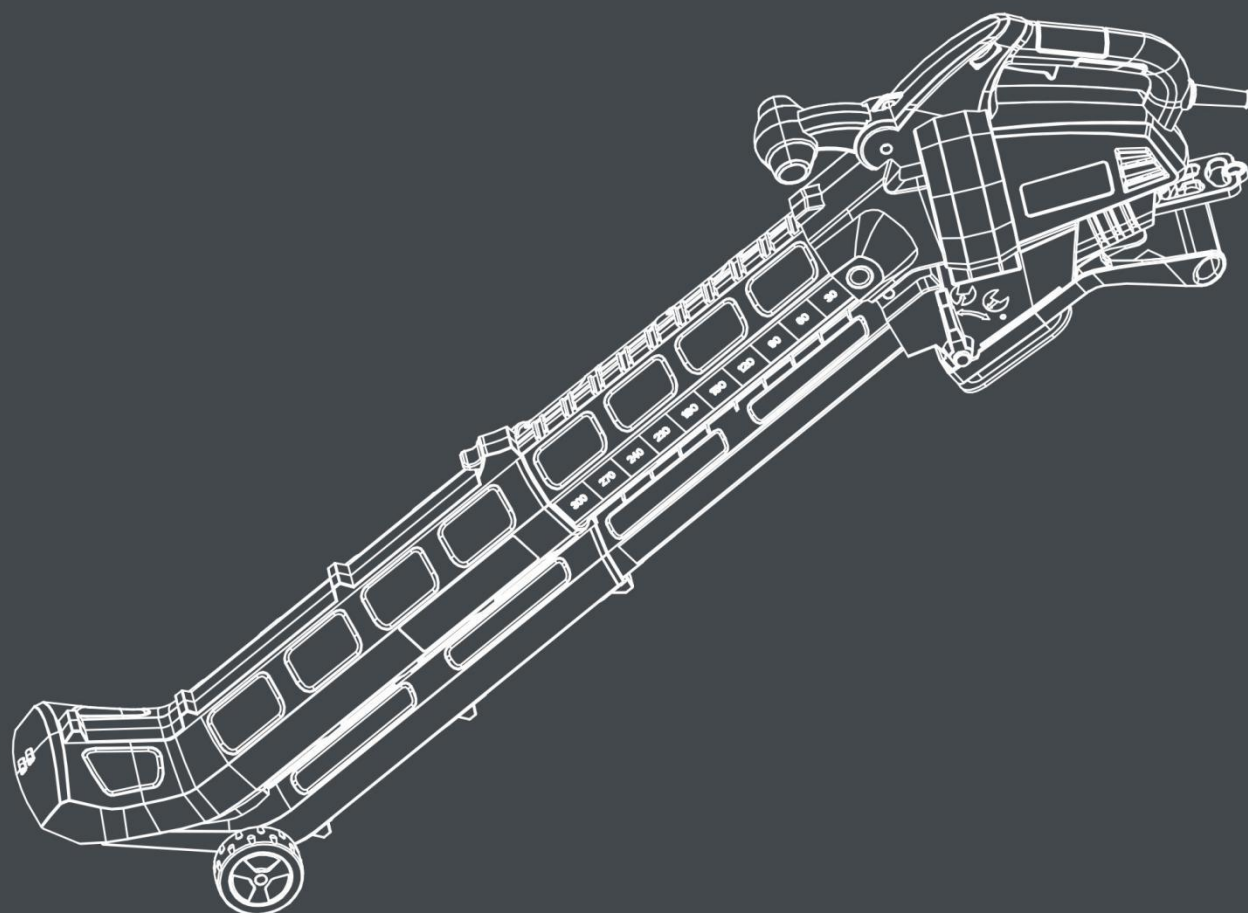

1.SAFETY WARNINGS

IMPORTANT READ CAREFULLY BEFORE USE KEEP FOR FUTURE REFERENCE

Safe operating practices for hand-held mains-operated electrical garden vacuums, and garden blower/vacuums with or without shredding means and garden blowers

Training

- a) Read the instructions carefully. Be familiar with the controls and the correct use of the machine.
- b) Never allow children or people unfamiliar with these instructions to use the machine.
- c) Local regulations can restrict the age of the operator.
- d) Keep in mind, that the operator or user is responsible for accidents or hazards occurring to other people or their property.

Preparation

- a) Obtain ear protection and safety glasses. Wear them at all times while operating the machine.
- b) While operating the machine always wear substantial footwear and long trousers. Do not operate the machine when barefoot or wearing open sandals. Avoid wearing clothing that is loose fitting or that has hanging cords or ties.
- c) Do not wear loose clothing or jewellery that can be drawn into the air inlet. Keep long hair away from the air inlets.
- d) Operate the machine in a recommended position and only on a firm, level surface.

- e) Do not operate the machine on a paved or gravel surface where ejected material could cause injury.
- f) Before using, always visually inspect to see, that the **shredding means**, **shredding means** bolts and other fasteners are secure, the housing is undamaged and that **guards** and screens are in place. Replace worn or damaged components in sets to preserve balance. Replace damaged or unreadable labels.
- g) Before use, check the supply and extension cord for signs of damage or aging. If the cord becomes damaged during use, disconnect the cord from the supply immediately. **DO NOT TOUCH THE CORD BEFORE DISCONNECTING THE SUPPLY.** Do not use the machine if the cord is damaged or worn.
- h) Never operate the machine while people, especially children, or pets are nearby.

Operation

- a) Before starting the machine, make certain that the feeding chamber is empty.
- b) Keep your face and body away from the feed intake opening.
- c) Do not allow hands or any other part of the body or clothing inside the feeding chamber, discharge chute, or near any moving part.
- d) Keep proper balance and footing at all times. Do not overreach. Never stand at a higher level than the base of the machine when feeding material into it.
- e) Always stand clear of the discharge zone when operating this machine.
- f) When feeding material into the machine be extremely careful that pieces of metal, rocks, bottles, cans or other foreign objects are not included.
- g) If the cutting mechanism strikes any foreign objects or if the machine should start making any

unusual noise or vibration, immediately shut off the power source and allow the machine to stop. Disconnect the machine from the supply and take the following steps before restarting and operating the machine:

- i) inspect for damage;
- ii) replace or repair any damaged parts;
- iii) check for and tighten any loose parts.
- h) Do not allow processed material to build up in the discharge zone; this may prevent proper discharge and can result in kickback of material through the intake opening.
- i) If the machine becomes clogged, shut-off the power source and disconnect the machine from supply before cleaning **debris**.
- j) Never operate the machine with defective **guards** or shields, or without safety devices, for example **debris collector** in place.
- k) Keep the power source clean of debris and other accumulations to prevent damage to the power source or possible fire.
- l) Do not transport this machine while the power source is running.
- m) Stop the machine, and remove plug from the socket. Make sure that all moving parts have come to a complete stop
 - whenever you leave the machine,
 - before clearing blockages or unclogging chute,
 - before checking, cleaning or working on the machine.
- n) Do not tilt the machine while the power source is running.

Maintenance and storage

- a) When the machine is stopped for servicing, inspection, or storage, or to change an accessory,

shut off the power source, disconnect the machine from the supply and make sure that all moving parts are come to a complete stop. Allow the machine to cool before making any inspections, adjustments, etc. Maintain the machine with care and keep it clean.

b) Store the machine in a dry place out of the reach of children.

c) Always allow the machine to cool before storing.

d) When servicing the **shredding means** be aware that, even though the power source is switched off due to the interlock feature of the **guard**, the **shredding means** can still be moved.

e) Replace worn or damaged parts for safety. Use only genuine replacement parts and accessories.

f) Never attempt to override the interlocked feature of the **guard**.

Additional safety instructions for units with bagging attachments

Switch-off the machine before attaching or removing the bag.

Recommendation

The machine should be supplied via a residual current device (RCD) with a tripping current of not more than 30 mA.

Additional instructions

- This appliance is not intended for use by persons (including children) with reduced physical, sensory or mental capabilities, or lack of experience and knowledge, unless they have been given supervision or instruction concerning use of the appliance by a person responsible for their safety. Children should be supervised to ensure that they do not play with the appliance.

- Do not allow children, people with reduced physical, sensory or mental abilities, or those with no experience and knowledge or people who do not know these instructions to use the machine. Local regulations may restrict the age of the operator.
- Do not use the machine when people, especially children, or pets are nearby.
- Remember that the operator or user is responsible for accidents or hazards that occur to people or their property
- Before connecting the machine, check:
 - If the tool and cable are not damaged. If anything is damaged, do not use the machine and return it to your dealer for inspection and repair.
 - The voltage marked on the nameplate of the tool corresponds to that of your electrical installation.
- Do not use accessories other than those recommended by the manufacturer; Accessories not recommended may damage the unit and / or cause injury.
- Do not disassemble the tool yourself. Any disassembly, repair or inspection must be performed by qualified personnel only.
- Use the tool fully assembled and secure. Before use, check that the guards and safety devices are in place.
- When operating the machine, always wear protective equipment including: face shield, visor or goggles, ear protection, helmet, gloves, non-slip shoes and protective clothing.
- Always carry the machine by its handle; Never use the cord or any other part of the machine.

- Do not use the machine when you are tired, under the influence of alcohol, drugs or when you are sick.
- Use the tool to vacuum and blow leaves and similar materials. Do not blow flammable materials, cigarette butts and materials that may damage the unit.
- Do not use the appliance to suck up water or wet debris.
- Always use the machine with the collection bag.
- Avoid using the machine in bad weather, especially when there is a risk of thunderstorms and lightning.
- In the event of an accident, stop using the machine immediately. Turn it off and unplug it to check the problem. Do not use the machine when it is damaged.
- Do not use the tool in an area where there is insufficient ventilation. Gas emissions can cause injury.
- Do not use the tool in humid places.
- Do not use the tool in the presence of flammable liquids or gases.
- Do not use the product with damaged guards or shields, shields or screens not in place.
- Do not bend. Keep a good balance at all times.
- Keep handles dry, clean and free of oil and grease.
- Use and handle the machine with care
- Do not put your body, clothing or shoes near the air opening.
- Do not lift the tool while it is running.
- Do not point the tool in front of people; this can lead to accidents and injuries.

- Do not place any objects inside the tube and inside the tool.
- Before using the machine and after a shock, check for signs of wear or damage. Please make repairs if necessary.
- Inspect and maintain the product regularly. Repairs should only be performed by an authorized service center or qualified specialist.
- Children should not play with plastic bags, sheets and small parts! Keep them out of the reach of children. There is a risk of suffocation!
- Do not use the product on a slippery surface.
- Do not use the product on steep, slippery slopes. If you need to work on the slopes, use extreme care and pay attention to your feet. Please wear non-slippery shoes.
- When planning your work schedule, allow enough time for rest. Limit continuous use of the device, for example, use 30 to 40 minutes per session and take 10 to 20 minutes of rest between work sessions. Work a maximum of two hours a day.
- Do not connect a damaged cable or touch a damaged cable before it is disconnected from the power supply; Damaged cables may cause contact with live parts.
- Keep extension cords away from hazardous moving parts to prevent damage to cords that may cause contact with live parts.
- When a cable is damaged or entangled, stop using the tool immediately. Turn off the tool, let it cool down and unplug it securely.
- Do not overreach and keep the balance at all times; always be sure of the footing on slopes. Walk, never run.

- Do not touch moving hazardous parts before the machine is disconnected from the mains and the moving hazardous parts have come to a complete stop.
- The extension cable shall not be lighter than the standardised code H05 RN-F/H05 VV-F. See your retailer or manufacturer for more advice.

Residual risks

Even if you use this product in accordance with all safety requirements, the risk of injury and damage remain. The following hazards may occur in the structure and design of this product:

- a. There is adverse health consequences resulting from the emission of vibrations if the product is used for long periods or if it is not properly handled and properly maintained.
- b. Risk of injury to persons and property caused by projectiles.
- c. Prolonged use of this product may expose the operator to vibration and may produce a so-called "white finger" disease. To reduce the risk, wear gloves and keep your hands warm.
- d. If any of the symptoms of "white finger syndrome" occur, seek medical attention immediately. "White finger" symptoms include numbness, loss of sensitivity, tingling, tingling, and pain, loss of strength, colour changes, or skin condition. These symptoms usually appear on the fingers, hands or wrists. The risk increases at low temperature.
- e. Inhalation of particles of blown / aspirated material
- f. Involuntary projections
- g. Contact with foreign bodies
- h. Contact with the tool in operation
- i. Hearing loss in the absence of proper hearing protection

2. Symbols

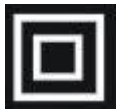

Class II product (double insulation)



Risk of bodily injury or property damage



Warning! Read instruction

manual



Be careful that persons in the vicinity are not injured by projections from the machine.



Keep those present away



Blower and vacuum

/ blower rotating blades can cause serious injury. CAUTION: Ventilation continues to

rotate when the lid is open or closed. Do not insert your hands or other objects



Switch off the tool and disconnect the plug from the mains before setting or cleaning the tool, or if the cable is tangled or damaged.



Never operate or leave the machine in the rain or in a humid environment. Moisture poses a risk of electric shock.



Wear safety glasses.



Wear ear protectors



Guarantee sound power

Intended use

- This vacuum blower is intended to be used for the vacuuming and the blowing of leaves, dust, and similar little materials. It must not to be used for vacuuming and blowing water, chemical products, flammable material, metal or wood and others dangerous objects.
- This product is intended for private domestic use only. It must be use outdoor.
- This product is not intended to be used in a closed room and places where exhausted gas and flames can be present.
- The use of this product in case of rain or humid environment is prohibited.
- Any other use might lead to damage of the appliance, property or personal injury.

3. DESCRIPTION

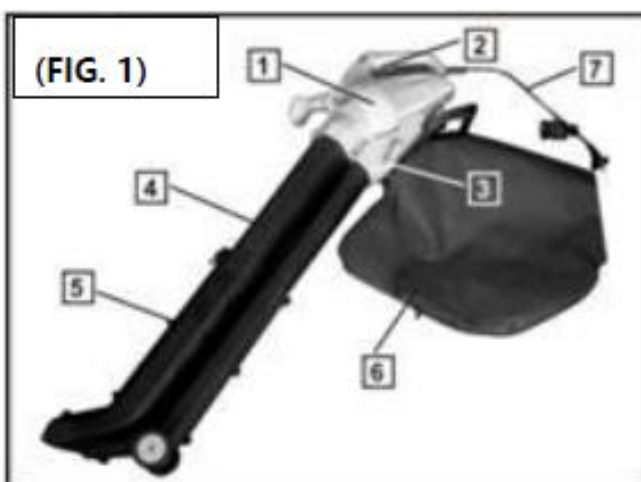

1. Body of the vacuum cleaner / blower
2. ON / OFF switch
3. Suction / Blow Selection Lever
4. Suction / Intermittent Tube
5. Suction / blowing tube equipped with wheels
6. Bag of pickup
7. Power cable
8. Anti-lock hatch

Technical specifications

Model	HAS30TCL
Power	3000W
No load speed	8000-14000/min
Tension	230V-240V~50Hz
Velocity of the blower	100-275 km/h
Maximum airflow for blower	13.5m ³ /min
Capacity of the bag of collection	45L

Weight	3.8kg
Sound pressure level	86.6dB(A) K=3dB(A)
Sound power level	98.1dB(A) K=2.07 dB(A)
Guarantee sound power level	100dB(A)
vibration	0.815 m/s ² K=1,5 m/s ²

4. **ASSEMBLY**

- Remove all packing materials.
- Remove the remaining packaging and transport media (if applicable).
- Check that nothing is missing in the box.
- Make sure that the unit, the power cord, the power plug, and all accessories have not been damaged during transport.
- Save the packing materials as long as possible until the end of the warranty period. Then dispose of them according to your waste disposal system.
- In case of missing or damaged parts, contact your dealer.



WARNING: Packaging materials are not toys! Children should not play with plastic bags! There is a risk of suffocation!



The vacuum cleaner / blower should not be used or energized until fully assembled.

4.1 Height adjustment (Fig. 2 + 3) Press the button (2.1) and slide the air line, it can be adjusted up to 300 mm

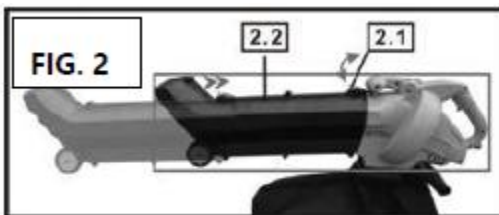

4.2 Installation of the grass catcher (Fig. 4+5)



Before installing the recovery bag, check that the selector lever of the vacuum cleaner / blower is working properly and that it is not clogged with debris from previous use.

To install the recovery bag:

- Turn the support frame (4.1) to the appropriate position of the housing (4.3).
- Lock the bracket in place.
- To remove the recovery bag:
- Press the bracket (4.2) to release it.

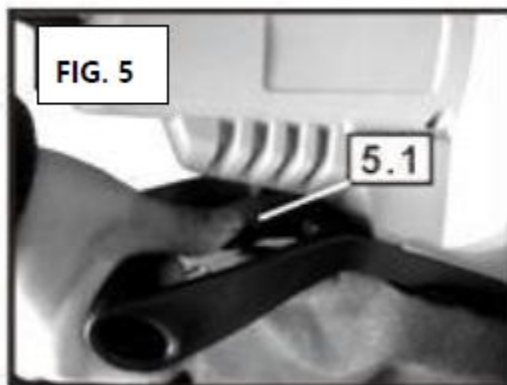
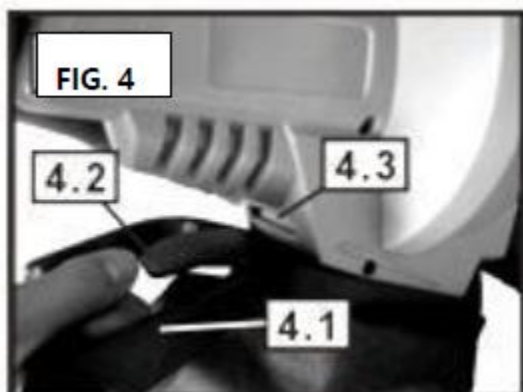

4.3 Installation of the shoulder strap (fig. 6)

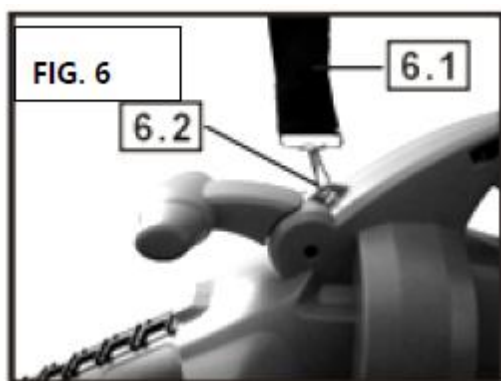

The vacuum cleaner / blower is equipped with a shoulder strap (6.1) fixed at the top of the main body of the vacuum cleaner / blower as illustrated (6.2). The shoulder strap is intended to reduce fatigue and facilitate the use of the vacuum cleaner /blower; it can be worn in the position that is convenient for the operator.

5. USE

Before starting the machine, make sure that collect bag is fitted and the shoulder harness is adjusted to a suitable working position.

5.1 Extension cord

The tool must be connected to an extension cord. Plug the tool cable into the extension. Then attach the extension to the cable holder to hold it.

The extension cable must not be lighter than the standard code H05 RN-F / H05 VV-F. Consult your dealer or manufacturer for further advice

5.2 Before start

Connect the vacuum cleaner / blower to the mains via DDR and switch it on. Check that the DDR is working properly.

5.3 Switching on the vacuum cleaner / blower (Fig. 7 + 8 + 9)

To start the vacuum / blower, check that the suction / discharge tube is properly mounted and secured to the recovery bag. Without the recovery bag installed, you cannot start the vacuum cleaner / blower as the connection point is equipped with a safety device.

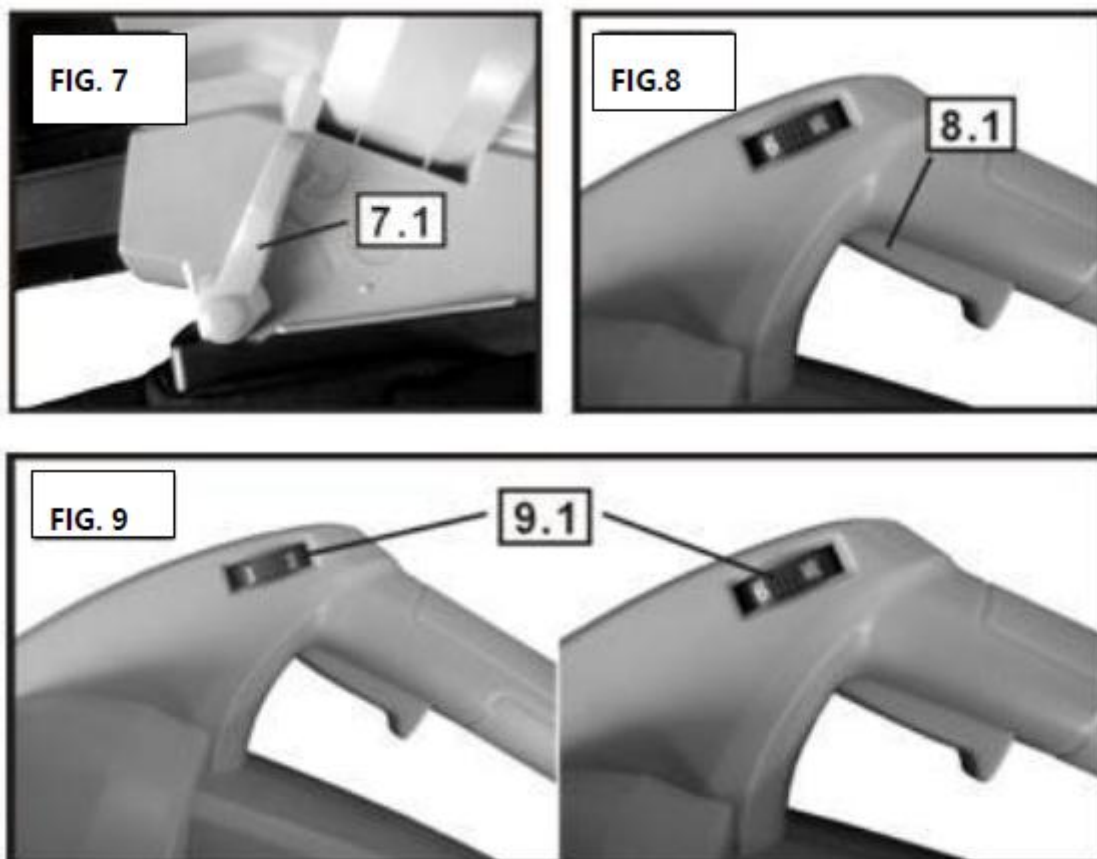

Warning! Before selecting the suction or blow function, check that the selector lever is working properly and that it is not obstructed by debris remaining from previous use.

Select the suction or blowing function using the selector lever located on the side of the appliance (7.1) and press the switch (8.1). If more power is required, slide the cruise control from position 1 at the max. (9.1).

5.4 Stopping the vacuum cleaner / blower (Fig.10)

To turn off the power, simply release the ON/OFF switch (10.1).

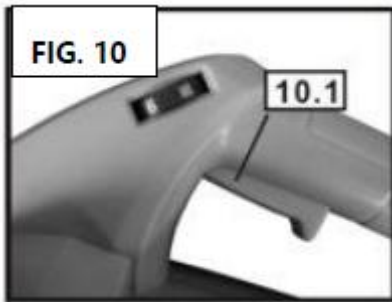

5.5 Use of the tool

Do not attempt to pick up wet debris, let dead leaves, etc., dry before using the vacuum cleaner / blower. The vacuum cleaner / blower can be used to remove debris from terraces, paths, walkways, lawns, bushes and curbs. It will also collect leaves, papers, small twigs and wood chips. When using the vacuum / blower in suction mode, debris is sucked into the suction tube before being ejected into the debris collection bag; debris is partially shredded as it passes through the suction fan. Shredded organic debris is ideal for use as mulch at the foot of plants.



- **Any hard objects, such as stones, cans, glass, etc., will damage the suction fan.**
- **Do not use the vacuum cleaner / blower to suck up water or very wet debris.**
- **Never use the vacuum cleaner / blower without the debris recovery bag installed.**

5.5.1 Mode blower

Inspect the work area before starting. Spread away any objects or debris that may be thrown, jammed, or tangled in the vacuum cleaner / blower.

Select the blowing function using the selector lever on the side of the unit and turn on the unit. The vacuum cleaner / blower resting on its wheels, move it while directing the nozzle towards the debris to evacuate.

Alternately hold the nozzle just above the floor and tilt the unit from side to side, moving it forward forwards and direct the nozzle to the debris to be evacuated. Blow debris into a pile, and then use the suction function to pick up debris.

5.5.2 Mode vacuum

Inspect the work area before starting. Spread away any objects or debris that may be thrown, jammed, or tangled in the vacuum cleaner / blower. Select the suction function using the selector lever on the side of the unit and switch on the unit. The vacuum cleaner / blower resting on its wheels, move it while directing the nozzle towards the debris to pick up. Alternately hold the nozzle just above the ground and tilt the unit from side to side, moving it forward forwards and point the nozzle at the debris to be picked up. Do not push the nozzle

into the debris too much as this will block the suction tube and reduce the efficiency of the device. Organic materials such as leaves contain a large amount of water that can cause them to stick to the inside of the suction tube. To limit the adhesion of these materials, they must dry a few days before being sucked.

6. MAINTENANCE AND STORAGE

WARNING! Do not use products that may damage the device (abrasives, corrosives, alcohol, steam cleaners, abrasive cloths, scrapers, etc.).

Do not install the unit in a dishwasher for cleaning!

The appliance must be completely switched off, unplugged and cold before cleaning.

a. Servicing

After each use:

- Remove the collection bag and empty the contents into a bin.
- Use a brush to remove debris from the fan and inside the tube.
- If necessary, you can clean the body of the tool with a soft, dry cloth.

b. Maintenance

After each use:

- Check that all nuts, bolts and screws are tight and that the safety devices are correctly positioned.
- Check if the machine has not been damaged. If the machine is damaged, you will need a qualified technician to inspect the machine and make repairs.

c. Storage

- Always clean the machine before storage.
- The tool, tube and bag must be stored in a well-ventilated, stable and level place.
- The tool must be out of the reach of children.

7. DISPOSAL



Electrical products should not be discarded with household products. According to the European Directive 2012/19/EU on waste electrical and electronic equipment and its implementation into national law, electrical products used must be collected separately and disposed of at collection points provided for this purpose. Talk with your local authorities or dealer for advice on recycling.

8. DECLARATION OF CONFORMITY



BUILDER SAS

ZI, 32 rue, Aristide Bergès – 31270 Cugnaux - France

Tel: +33 (0)5.34.502.502 Fax: +33 (0)5.34.502.503

Declare that the machine

VACUUM/BLOWER

HAS30TCL

Serial number: [20200811345-20200811844](#)

Is in conformity with the following Directive

Directive Machine 2006/42/EC

EMC Directive 2014/30/EU

Directive ROHS 2011/65/EU

Directive Noise 2000/14/EC Annex V and 2005/88/EC

Measured sound power level: 98.1dB(A)

Guarantee sound power level: 100dB(A)

Is in conformity with the following standards

EN 60335-1:2012/A2:2019

EN50636-2-100: 2014

EN 62233-2008

EN55014-1:2006+A1:2009+A2:2011

EN55014-2:2015

EN 61000-3-2:2014

EN 61000-3-3:2013

Philippe MARIE/PDG

Cugnaux, 28/06/2020

Responsable du fichier technique: Mr Olivier PATRIARCA

9. WARRANTY

HYUNDAI

WARRANTY

The manufacturer guarantees the product against defects in material and workmanship for a period of 2 years from the date of the original purchase. The warranty only applies if the product is for household use. The warranty does not cover breakdowns due to normal wear and tear.

The manufacturer agrees to replace parts identified as defective by the designated distributor. The manufacturer does not accept responsibility for the replacement of the machine, in whole or in part, and/or ensuing damage.

The warranty does not cover breakdowns due to:

- insufficient maintenance.
- abnormal assembly, adjustment or operations of the product.
- parts subject to normal wear and tear.

The warranty does not extend to:

- shipping and packaging costs.
- using the tool for a purpose other than that for which it was designed.
- the use and maintenance of the machine done in a manner not described in the user manual.

Due to our policy of continuous product improvement, we reserve the right to alter or change specifications without notice. Consequently, the product may be different from the information contained therein, but a modification will be undertaken without notice if it is recognized as an improvement of the preceding characteristic.

READ THE MANUAL CAREFULLY BEFORE USING THE MACHINE.

When ordering spare parts, please indicate the part number or code, you can find this in the spare parts list in this manual. Keep the purchase receipt; without it, the warranty is invalid. To help you with your product, we invite you to contact us by phone or via our website:

- **+33 (0)9.70.75.30.30**
- **<https://services.swap-europe.com/contact>**

You must create a "ticket" via the web platform.

- Register or create your account.
- Indicate the reference of the tool.
- Choose the subject of your request.
- Describe your problem.
- Attach these files: invoice or sales receipt, photo of the identification plate (serial number), photo of the part you need (for example: pins on the transformer plug which are broken).



10. PRODUCT FAILURE

WHAT TO DO IF MY MACHINE BREAKS DOWN?

If you bought your product in a store:

- a) Empty the fuel tank.
- b) Make sure that your machine is complete with all accessories supplied, and clean! If this is not the case, the repairer will refuse the machine.

Go to the store with the complete machine and with the receipt or invoice.

If you bought your product on a website:

- a) Empty the fuel tank.
- b) Make sure that your machine is complete with all accessories supplied, and clean! If this is not the case, the repairer will refuse the machine.
- c) Create a SWAP-Europe service ticket on the site: <https://services.swap-europe.com> When making the request on SWAP-Europe, you must attach the invoice and the photo of the nameplate (serial number).
- d) Contact the repair station to make sure it is available before dropping off the machine.

Go to the repair station with the complete machine packed, accompanied by the purchase invoice and the station support sheet downloadable after the service request is completed on the SWAP-Europe site

For machines with engine failure from manufacturers BRIGGS & STRATTON, HONDA and RATO, please refer to the following instructions.

Repairs will be done by approved engine manufacturers of these manufacturers, see their site:

- <http://www.briggsandstratton.com/eu/fr>
- <http://www.honda-engines-eu.com/fr/service-network-page;jsessionid=5EE8456CF39CD572AA2AEEDFD290CDAE>
- <https://www.rato-europe.com/it/service-network>

Please keep your original packaging to allow for after-sales service returns or pack your machine with a similar cardboard box of the same dimensions.

For any question concerning our after-sales service you can make a request on our website <https://services.swap-europe.com>

Our hotline remains available at +33 (9) 70 75 30 30.



11. WARRANTY EXCLUSIONS

THE WARRANTY DOES NOT COVER:

- Start-up and setting up of the product.
- Damage resulting from normal wear and tear of the product.
- Damage resulting from improper use of the product.
- Damage resulting from assembly or start-up not in accordance with the user manual.
- Breakdowns related to carburetion beyond 90 days and fouling of carburetors.
- Periodic and standard maintenance events.
- Actions of modification and dismantling that directly void the warranty.
- Products whose original authentication marking (brand, serial number) has been degraded, altered or withdrawn.
- Replacement of consumables.
- The use of non-original parts.
- Breakage of parts following impacts or projections.
- Accessories breakdowns.
- Defects and their consequences linked to any external cause.
- Loss of components and loss due to insufficient screwing.
- Cutting components and any damage related to the loosening of parts.
- Overload or overheating.
- Poor power supply quality: faulty voltage, voltage error, etc.
- Damages resulting from the deprivation of enjoyment of the product during the time necessary for repairs and more generally the costs related to the immobilization of the product.
- The costs of a second opinion established by a third party following an estimate by a SWAP-Europe repair station
- The use of a product which would show a defect or a breakage which was not the subject of an immediate report and/or repair with the services of SWAP-Europe.
- Deterioration linked to transport and storage*.
- Launchers beyond 90 days.
- Oil, petrol, grease.
- Damages related to the use of non-compliant fuels or lubricants.

* In accordance with transport legislation, damage related to transport must be declared to carriers within 48 hours maximum after observation by registered letter with acknowledgement of receipt.

This document is a supplement to your notice, a non-exhaustive list.

Attention: all orders must be checked in the presence of the delivery person. In case of refusal by the delivery person, it you must simply refuse the delivery and notify your refusal.

Reminder: the reserves do not exclude the notification by registered letter with acknowledgement within 72 hours.

Information:

Thermal devices must be wintered each season (service available on the SWAP-Europe site). Batteries must be charged before being stored.

HYUNDAI
POWER PRODUCTS

For Inquiries, please contact:

BUILDER SAS

32, rue Aristide Bergès Z1 31270 Cugnaux, France

Tél. : +33 (0) 5.34.502.502 Fax : +33 (0) 5.34.502.503

<http://www.hyundaipower-fr.com/>

Fabriqué en République Populaire de Chine (PRC)